

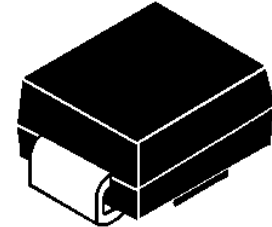

3000W Surface Mount Transient Voltage Suppressors

Features

- Peak power dissipation 3000W @10 x 1000 us Pulse
- Low profile package.
- Excellent clamping capability.
- Typical I_R less than 2uA when V_{BR} above 12V.
- Glass passivated junction.
- Very fast response time.
- IEC 61000-4-2 ESD 30KV(Air), 30KV(Contact)
- ESD protection of data lines in accordance with IEC 61000-4-2
- EFT protection of data lines in accordance with IEC 61000-4-4
- Halogen free and RoHS compliant
- Lead-free finish



SMC



Bi-directional



Uni-directional

Mechanical Characteristics

- CASE: SMC (DO-214AB) Molded Plastic over glass passivated junction.
- Mounting Position: Any
- Polarity: by cathode band denotes uni-directional device, none cathode band denotes bi-directional device.
- Terminal: Solder plated

Maximum Ratings and Characteristics @ 25°C Ambient Temperature (unless otherwise noted)

Parameter	Symbol	Value	Units
Peak Pulse Power Dissipation on 10/1000 us Waveform (Note 1, 2, FIG.1)	P_{PPM}	3000	W
Power Dissipation on Infinite Heat Sink at $T_L=50^\circ\text{C}$	P_D	6.5	W
Peak Pulse Current of on 10/1000us Waveform (Note 1, FIG.3)	I_{PPM}	See Table 1	A
Peak Forward Surge Current, 8.3ms Single Half Sine-Wave (Note 2. 3)	I_{FSM}	300	A
Operating Junction Temperature Range	T_J	-55 to 150	$^\circ\text{C}$
Storage Temperature Range	T_{STG}	-55 to 150	$^\circ\text{C}$

Notes:

1. Non-repetitive current pulse, per Fig.3 and derated above $T_A=25^\circ\text{C}$ per Fig.2.
2. Mounted on $8.0 \times 8.0 \text{mm}^2$ (0.03mm thick) Copper Pads to each terminal.
3. Measured on 8.3ms single half sine-wave, or equivalent square wave, for Unidirectional device only.

3.0SMC Series

Electrical Specification @ Tamb 25°C

Type Number		Reverse Stand-off Voltage	Breakdown Voltage Min. @I _r	Breakdown Voltage Max.@I _T	Test Current	Maximum Clamping Voltage @I _{PP}	Peak Pulse Current	Reverse Leakage @V _{RWM}
(Uni)	(Bi)	V _{RWM} (V)	V _{BR MIN} (V)	V _{BR MAX} (V)	I _T (mA)	V _C (V)	I _{PP} (A)	I _R (μ A)
3.0SMC6.8A	3.0SMC6.8CA	5.8	6.45	7.14	10	10.5	285.7	800
3.0SMC7.5A	3.0SMC7.5CA	6.4	7.13	7.88	10	11.3	265.5	500
3.0SMC8.2A	3.0SMC8.2CA	7.02	7.79	8.61	10	12.1	247.9	200
3.0SMC9.1A	3.0SMC9.1CA	7.78	8.65	9.55	1	13.4	223.9	100
3.0SMC10A	3.0SMC10CA	8.55	9.5	10.5	1	14.5	206.9	10
3.0SMC11A	3.0SMC11CA	9.4	10.5	11.6	1	15.6	192.3	5
3.0SMC12A	3.0SMC12CA	10.2	11.4	12.6	1	16.7	179.6	5
3.0SMC13A	3.0SMC13CA	11.1	12.4	13.7	1	18.2	164.8	1
3.0SMC15A	3.0SMC15CA	12.8	14.3	15.8	1	21.2	141.5	1
3.0SMC16A	3.0SMC16CA	13.6	15.2	16.8	1	22.5	133.3	1
3.0SMC18A	3.0SMC18CA	15.3	17.1	18.9	1	25.2	119.0	1
3.0SMC20A	3.0SMC20CA	17.1	19	21	1	27.7	108.3	1
3.0SMC22A	3.0SMC22CA	18.8	20.9	23.1	1	30.6	98.0	1
3.0SMC24A	3.0SMC24CA	20.5	22.8	25.2	1	33.2	90.4	1
3.0SMC27A	3.0SMC27CA	23.1	25.7	28.4	1	37.5	80.0	1
3.0SMC30A	3.0SMC30CA	25.6	28.5	31.5	1	41.4	72.5	1
3.0SMC33A	3.0SMC33CA	28.2	31.4	34.7	1	45.7	65.6	1
3.0SMC36A	3.0SMC36CA	30.8	34.2	37.8	1	49.9	60.1	1
3.0SMC39A	3.0SMC39CA	33.3	37.1	41	1	53.9	55.7	1
3.0SMC43A	3.0SMC43CA	36.8	40.9	45.2	1	59.3	50.6	1
3.0SMC47A	3.0SMC47CA	40.2	44.7	49.4	1	64.8	46.3	1
3.0SMC51A	3.0SMC51CA	43.6	48.5	53.6	1	70.1	42.8	1
3.0SMC56A	3.0SMC56CA	47.8	53.2	58.8	1	77	39.0	1
3.0SMC62A	3.0SMC62CA	53	58.9	65.1	1	85	35.3	1
3.0SMC68A	3.0SMC68CA	58.1	64.6	71.4	1	92	32.6	1
3.0SMC75A	3.0SMC75CA	64.1	71.3	78.8	1	103	29.1	1
3.0SMC82A	3.0SMC82CA	70.1	77.9	86.1	1	113	26.5	1
3.0SMC91A	3.0SMC91CA	77.8	86.5	95.5	1	125	24.0	1
3.0SMC100A	3.0SMC100CA	85.5	95	105	1	137	21.9	1
3.0SMC110A	3.0SMC110CA	94	105	116	1	152	19.7	1
3.0SMC120A	3.0SMC120CA	102	114	126	1	165	18.2	1
3.0SMC130A	3.0SMC130CA	111	124	137	1	179	16.8	1
3.0SMC150A	3.0SMC150CA	128	143	158	1	207	14.5	1
3.0SMC160A	3.0SMC160CA	136	152	168	1	219	13.7	1
3.0SMC170A	3.0SMC170CA	145	162	179	1	234	12.8	1

※ For Bi-directional type having V_{RWM} of 10 Volts and less, the I_R limit is double.

※ For parts without A, the VBR is \pm 10% and VC is 5% higher than with A par

I-V Curve Characteristics

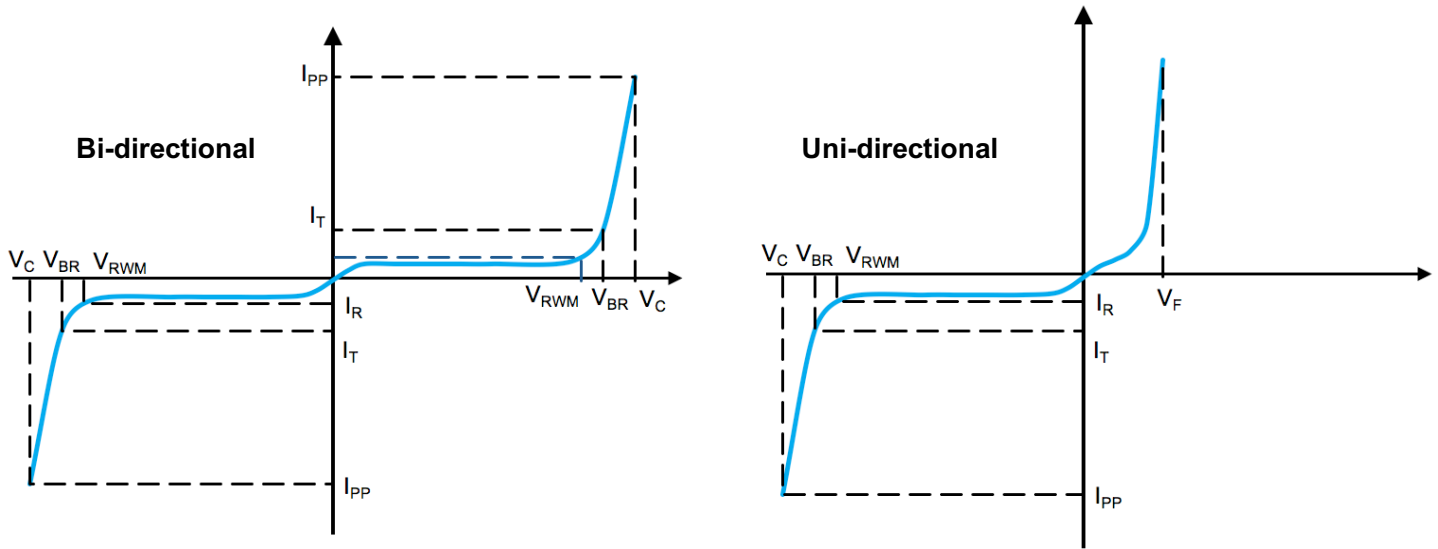

- P_{PPM} Peak Pulse Power Dissipation** - Max power dissipation
- V_{RWM} Reverse Stand-off Voltage** - Maximum voltage that can be applied to TVS without operation
- V_{BR} Breakdown Voltage** – Maximum voltage that flows through the TVS at a specified current (I_T)
- V_C Clamping Voltage** – Peak voltage measured across the TVS at a specified I_{PPM} (peak impulse current)
- I_R Reverse Leakage Current** – Current measured at V_R
- V_F Forward Voltage Drop for Uni-directional**

Ratings and Characteristic Curves ($T_A=25^\circ\text{C}$ unless otherwise noted)

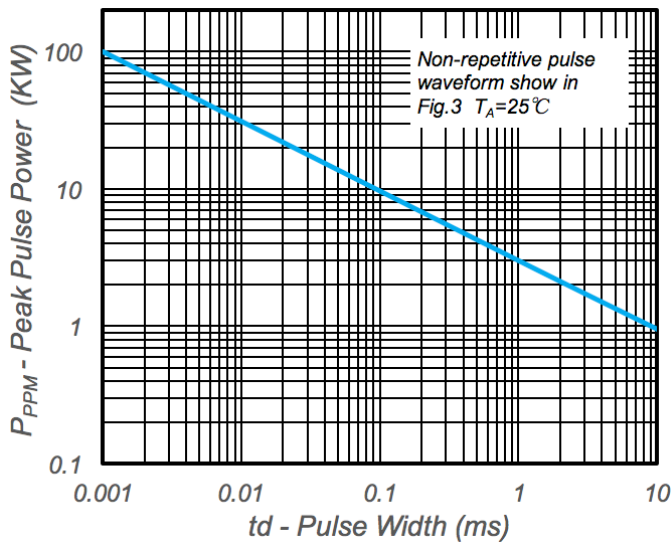

Fig.1 - Peak Pulse Power Rating

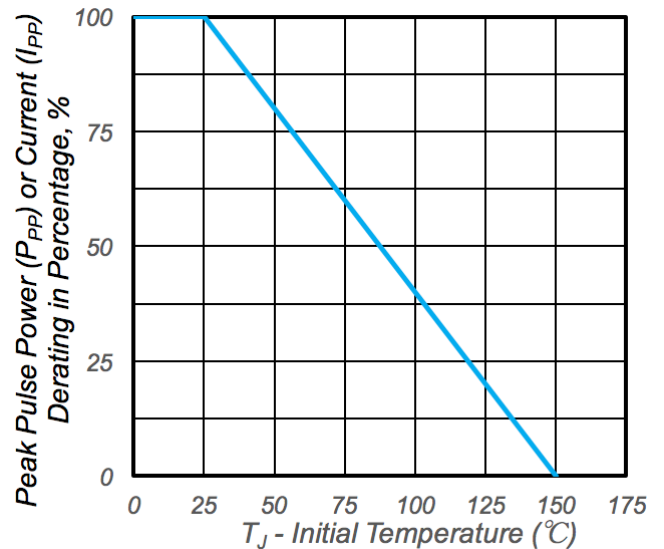
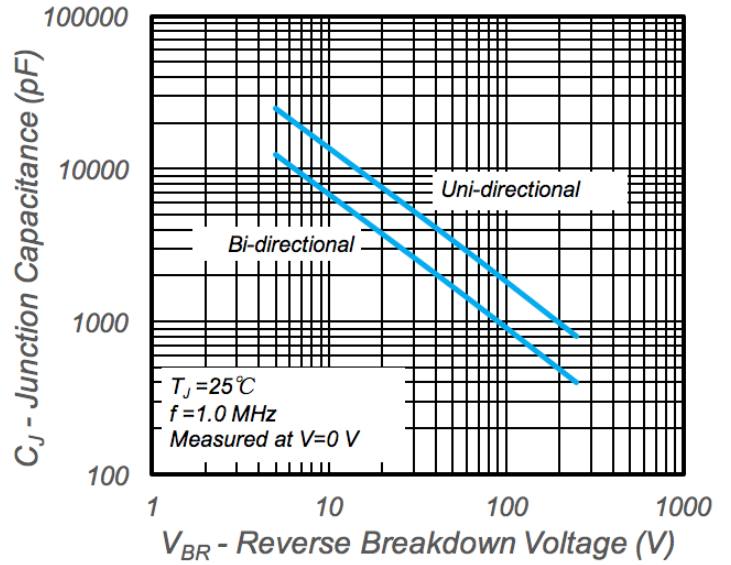
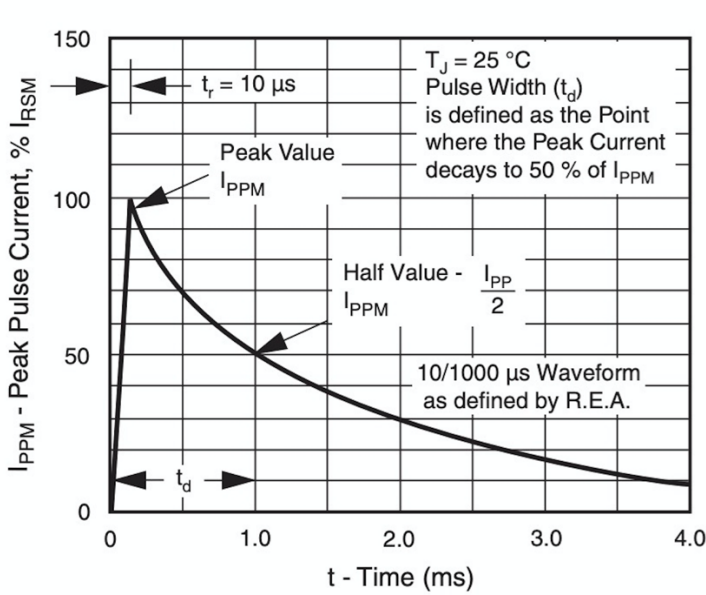
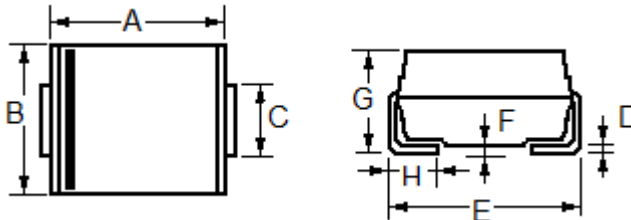

Fig.2 - Pulse Derating Curve



Package Outline Dimensions and Pad Layouts

DO-214AB (SMC)



Dim	Millimeters		Inches	
	Min	Max	Min	Max
A	6.60	7.11	0.260	0.280
B	5.59	6.22	0.220	0.245
C	2.90	3.20	0.114	0.126
D	0.125	0.305	0.006	0.012
E	7.75	8.13	0.305	0.320
F	----	0.203	----	0.008
G	2.06	2.62	0.079	0.103
H	0.76	1.52	0.030	0.060